

**B502** 4.1 kg | 0.33 m<sup>3</sup>/2 pcs

**B502D** 4.1 kg | 0.33 m<sup>3</sup>/2 pcs

**CHAIR.** Seat shell in painted, compression moulded, layer-glued wood veneer or upholstered in fabric or leather with polyurethane padding. Chrome plated (chrome III) or painted steel frame. Plastic foot. Paint finishes are applied to ash veneer. Refer to the list below for suitable fabrics for Dent. Please consult us for other fabric selections.

Dent is also available as a barstool, height 65 cm and 82 cm.

	<b>B502</b>
Seat height	46
Overall height	78
Seat width	41
Overall width	42
Seat depth	38
Overall depth	52
Weight, kg	4.45
Cbm	0.33/2 pcs

	<b>B502D</b>
Seat height	46
Overall height	78
Seat width	41
Overall width	42
Seat depth	38
Overall depth	52
Weight, kg	4.45
Cbm	0.33/2 pcs





**B501** 4.35 kg | 0.32 m<sup>3</sup>/4 pcs 

**B501D** 4.35 kg | 0.32 m<sup>3</sup>/4 pcs 

**CHAIR.** Seat shell in painted, compression moulded, layer-glued wood veneer or upholstered in fabric or leather with polyurethane padding. Chrome plated (chrome III) or painted steel frame. Plastic foot. Paint finishes are applied to ash veneer. Refer to the list below for suitable fabrics for Dent. Please consult us for other fabric selections.

Dent is also available as a barstool, height 65 cm and 82 cm, but then it is not stackable.

	<b>B501</b>
Seat height	46
Overall height	78
Seat width	41
Overall width	50
Seat depth	38
Overall depth	52
Weight, kg	4.35
Cbm	0.32/4 pcs

	<b>B501D</b>
Seat height	46
Overall height	78
Seat width	41
Overall width	50
Seat depth	38
Overall depth	52
Weight, kg	4.15
Cbm	0.32/4 pcs



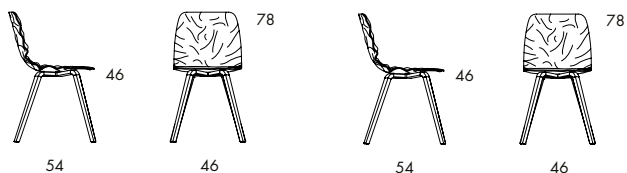

**B504** 4.95 kg | 0.32 m<sup>3</sup>/2 pcs

**B504D** 4.95 kg | 0.32 m<sup>3</sup>/2 pcs

**CHAIR.** Seat shell in painted, compression moulded, layer-glued wood veneer or upholstered in fabric or leather with polyurethane padding. Underframe in clearlacquered or stained compression-moulded wood veneer. Plastic foot. Paint finishes are applied to ash veneer. Refer to the list below for suitable fabrics for Dent. Please consult us for other fabric selections.

Dent Wood is also available as a barstool, height 65 cm and 82 cm.

	<b>B504</b>
Seat height	46
Overall height	78
Seat width	41
Overall width	46
Seat depth	38
Overall depth	54
Weight, kg	4.95
Cbm	0.32/2 pcs

	<b>B504D</b>
Seat height	46
Overall height	78
Seat width	41
Overall width	46
Seat depth	38
Overall depth	54
Weight, kg	4.95
Cbm	0.32/2 pcs



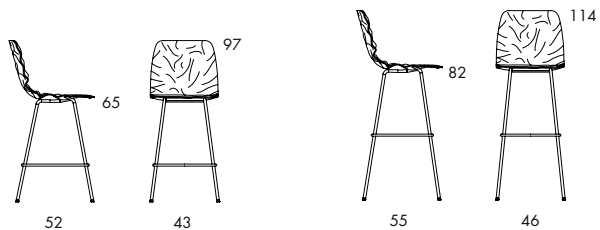

**B502-65** 6 kg | 0.36 m<sup>3</sup>/pc

**B502-82** 6.45 kg | 0.44 m<sup>3</sup>/pc

**BAR CHAIR.** Seat shell in painted, compression moulded, layer-glued wood veneer or upholstered in fabric or leather with polyurethane padding. Chrome plated (chrome III) or painted steel frame. Plastic foot. Paint finishes are applied to ash veneer. Refer to the list below for suitable fabrics for Dent. Please consult us for other fabric selections.

Dent Bar is also available as an ordinary chair.

	<b>B502-65</b>		<b>B502-82</b>
Seat height	65	Seat height	82
Overall height	97	Overall height	114
Seat width	41	Seat width	41
Overall width	43	Overall width	46
Seat depth	38	Seat depth	38
Overall depth	52	Overall depth	55
Weight, kg	6	Weight, kg	6.45
Cbm	0.36	Cbm	0.44



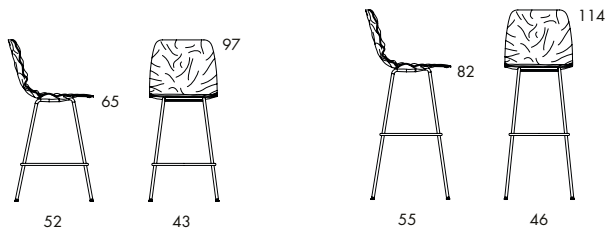

**B502D-65** 6.4 kg | 0.36 m<sup>3</sup>/pc

**B502D-82** 6.85 kg | 0.44 m<sup>3</sup>/pc

**BAR CHAIR.** Seat shell in painted, compression moulded, layer-glued wood veneer or upholstered in fabric or leather with polyurethane padding. Chrome plated (chrome III) or painted steel frame. Plastic foot. Paint finishes are applied to ash veneer. Refer to the list below for suitable fabrics for Dent. Please consult us for other fabric selections.

Dent Bar is also available as an ordinary chair.

	<b>B502D-65</b>
Seat height	65
Overall height	97
Seat width	41
Overall width	43
Seat depth	38
Overall depth	52
Weight, kg	6.4
Cbm	0.36

	<b>B502D-82</b>
Seat height	82
Overall height	114
Seat width	41
Overall width	46
Seat depth	38
Overall depth	55
Weight, kg	6.85
Cbm	0.44



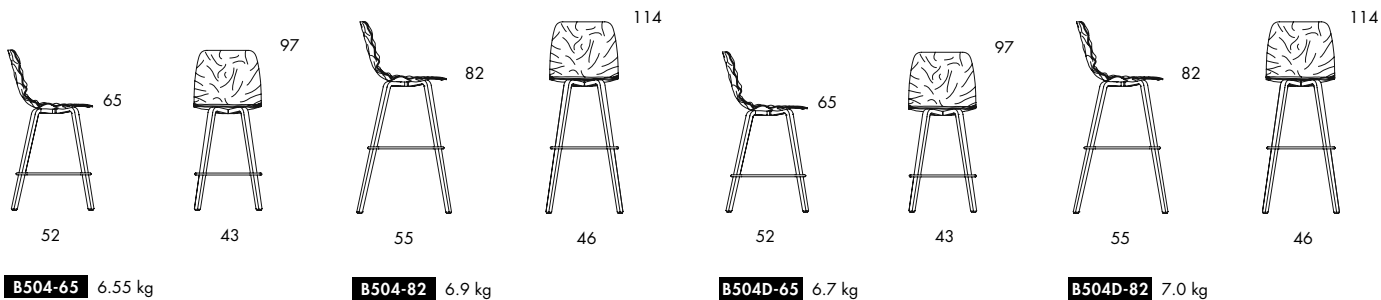

**BAR CHAIR.** Seat shell in painted, compression moulded, layer-glued wood veneer or upholstered in fabric or leather with polyurethane padding. Underframe in clearlacquered or stained compression-moulded wood veneer. Stainless steel foot ring.

Dent Wood Bar is also available as an ordinary chair.

	<b>B504-65</b>		<b>B504-82</b>
Seat height	65	Seat height	82
Overall height	97	Overall height	114
Seat width	42	Seat width	42
Overall width	43	Overall width	46
Seat depth	40	Seat depth	40
Overall depth	55	Overall depth	55

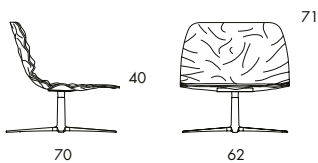

**B505D**

**SWIVEL EASY-CHAIR.** Seat shell of compression moulded wood veneer and polyurethane padding. Upholstered in fabric or leather. Black lacquered swivel base in steel. Plastic foot. Refer to the fabric list in the pricelist under Dent Lounge for suitable fabrics. Please consult us for other fabric selections. Dent is a large family that also includes chairs and barstools with seatshells in wood or dressed versions.

	<b>B18</b>
Seat height	41
Overall height	72
Seat width	67
Overall width	72
Seat depth	56
Overall depth	70



**Inspire. Create. Deliver.**